GREAT BRITISH BATHROOM FURNITURE



MADE BETTER BY

ELLIS



 **MADE
BETTER
IN BRITAIN**

MADE BETTER IN BRITAIN SINCE 1891

We're proud to still be a family-owned business, with the fourth Ellis generation now at the helm. With over 130 years' experience creating beautiful bathrooms, we take as much care over the craft today as our great grandfather did. So whatever vision you have for your space, you can be assured you'll be buying the best bathroom products on the market, built with love and made to last.

By creating bathrooms that are made better, we've earned a deserved reputation for high standards, outstanding attention to detail and exceptional value for money. This makes us one of the most trusted brands in today's marketplace.

All our ranges are handcrafted by skilled tradesmen using conventional cabinet making skills. We use a unique 'double glue and dowel' system for a stronger build process which is not common in the industry. This means you can be safe in the knowledge that your Ellis bathroom furniture will last for a lifetime.

Our beautiful bathroom furniture is all made to order specifically for your space and delivered to your local retailer in a maximum of just three weeks.



Simply Register your guarantee online for complete peace of mind. This guarantee covers all furniture manufactured by J.T. Ellis. Sanitary ware, brassware and all non-Ellis manufactured products carry their own guarantee.

PRICE BAND **A**



Stretton **14**
Novo **18**
Remo **22**
Azura **26**

PRICE BAND **B**



Flare **32**
Element **36**
Exel **40**
Inzo **44**
Malbis **48**

PRICE BAND **C**



Kensington **54**
Rosedale **58**
Hampshire **62**
Hepworth **66**
Elevate **70**

OPTIONS AND INFORMATION



Finishing Touches and Technical Specification 72	WC's 88
Colour Options 74	Flush Buttons 90
Carcase Colours 77	Taps 91
Handles 78	Cabinet Sizes 92
Worktops 80	Guarantee & Customer Care 94
Basins 82	

OUR HISTORY...



1891

J.T. Ellis establishes the company, manufacturing baptism fonts and church furniture

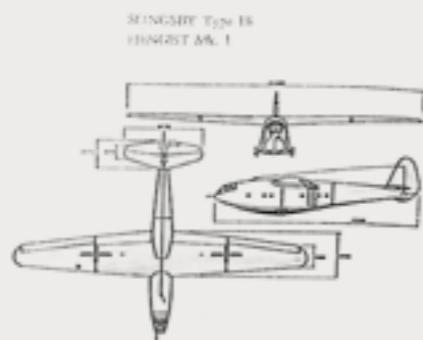

1940s

J.T. Ellis manufacture school furniture, writing bureaux and aeroplane wings



1960s

Third generation of the family, Roger, Charles and James join the business



1990s

Tom & Richard (J.T. Ellis' great grandchildren) join the family business

2020s

Investment made into the very latest automated production machinery for enhanced efficiency, quality and scale

1920s

Second generation of the family, Bill, Edward and Tom join the business



1950s

J.T. Ellis begin manufacture of domestic kitchens for housebuilders and retailers, including Harrods



1980s

New factory built on Silver Street Huddersfield for expanding operation



2000s

J.T. Ellis continue to manufacture quality kitchen and bathroom furniture at the Huddersfield factory

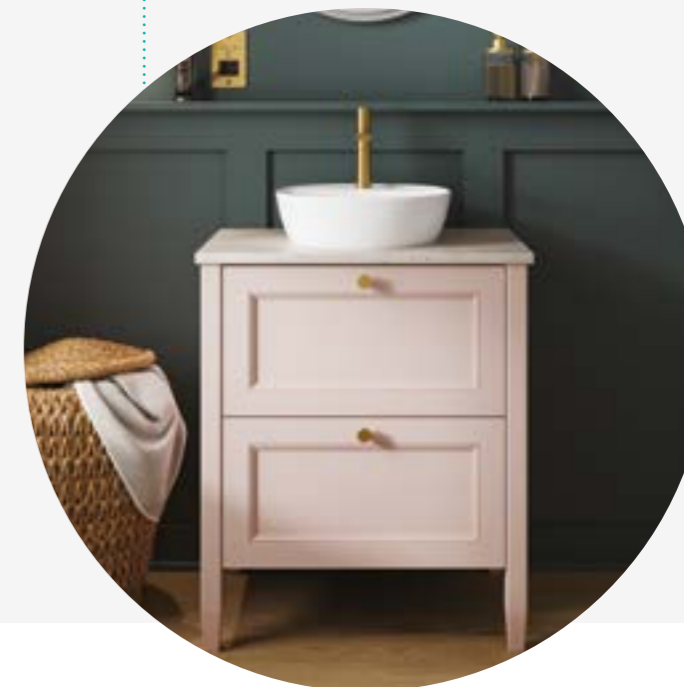

A WORLD OF POSSIBILITIES

Whatever the shape and size of your bathroom, Ellis furniture is designed to fit just how you want it. With a huge range of units to choose from, built to slot together in almost any combination, as well as numerous finishes and colours to ponder, there is virtually no limit to what we can create for you. Whether you opt for modular furniture or a seamless fitted solution, the world is your oyster.



PRICE BAND A & B

Our price band A & B bathrooms include 9 ranges covering 51 colours and finishes. They are available in a wide range of floorstanding and wall mounted options, including space saving units. To order your furniture simply choose your preferred style, colour and dimensions.

PRICE BAND C - THE 1891 COLLECTION

30 hand painted colours and a choice of 5 door styles. Our beautifully crafted 1891 washstand collection is available in a palette of 30 on-trend water based paint colours which reduce our impact on the environment without compromising on quality.

To order your 1891 furniture, simply choose your preferred style, colour and dimensions.

COLOUR LIKE NEVER BEFORE

Colour is bolder than ever in bathroom design, so be brave and go where your imagination takes you. Mix and match or keep it simple... the choice is yours.

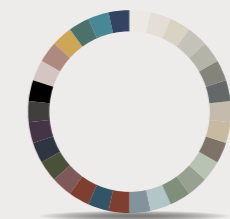

81
FINISHES
AVAILABLE

SHOP OUR RANGE IN 5 EASY STEPS

01 CHOOSE YOUR DOOR STYLE & FINISH

Start by selecting your perfect door style and color to complement your bathroom's finish and reflect your unique personality

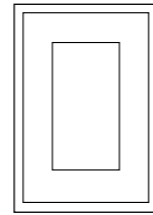

02 CHOOSE YOUR CARCASE COLOUR

Select your preferred carcass colour, either to match your door or to contrast to create a truly individual style. (see page 72 for colour options)

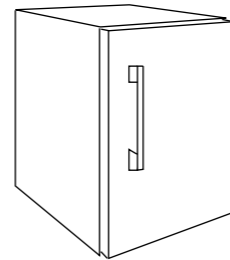

03 CHOOSE YOUR HANDLE STYLE

The right handle selection and positioning can transform the look of your bathroom, from ultra-modern to elegantly traditional. Choose from our wide range of handles. (see pages 76-77 for options)

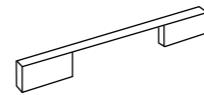

04 CHOOSE YOUR WORKTOP

Choose from our range of worktop materials including laminate and composite stone all available in classic and contemporary finishes. (see pages 78-79 for options)

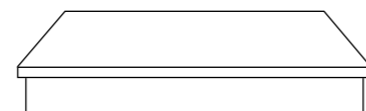

05 CHOOSE YOUR TAPS AND SANITARYWARE

Taps and sanitaryware can have a major effect on the overall look of your bathroom. Choose from our contemporary, classic and traditional styles. (see pages 80-89 for options)

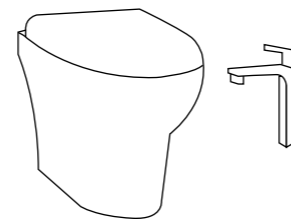

FITTED OR MODULAR FURNITURE?

FITTED FURNITURE

Fitted bathroom furniture is designed as a single, cohesive unit that is custom-built and installed to fit a specific space in your bathroom. It seamlessly integrates with the dimensions of your bathroom, often spanning from wall to wall ensuring a precise fit.

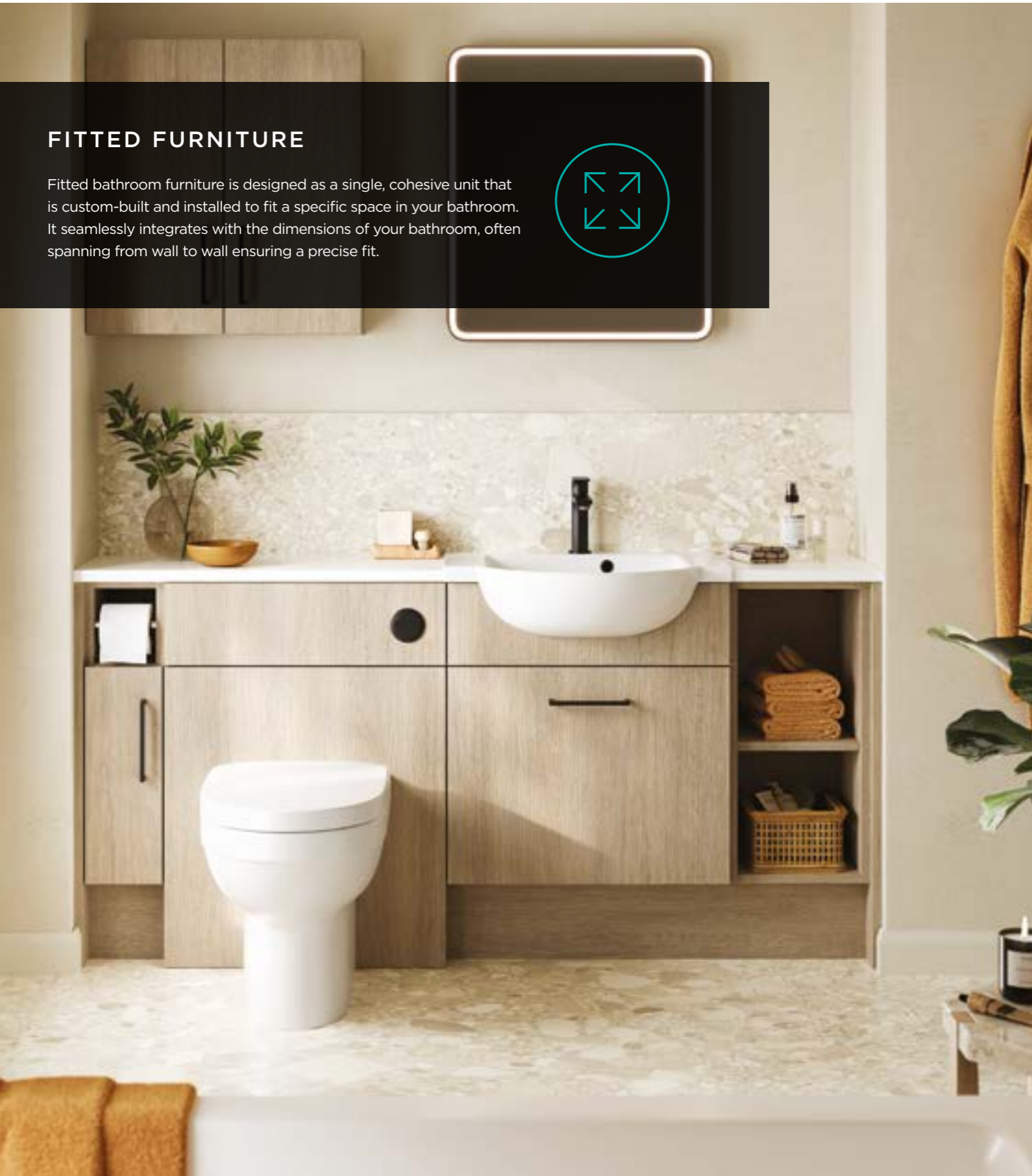

MODULAR & WASHSTAND FURNITURE

Modular and washstand bathroom furniture offers versatility and ease of installation. It allows you to mix and match individual pieces to achieve a personalised setup. Modular and washstand furniture generally sits independently from other fixtures in your bathroom, such as your toilet, and is available in either floor-standing or wall-hung options and requires less space compared to a fully fitted bathroom.





PRICE BAND A



Our four Price Band A ranges Stretton, Novo, Remo and Azura are on colour matching carcasses and are available in a wide choice of solid colours, natural woodgrains and mid gloss finishes. Browse the following pages to see these ranges in a variety of finishes and how they can bring life and tranquillity to your new bathroom.

FINISHES

STRETTON & NOVO

					
Platinum White	Cashmere	Antique Rose	Rusty Red	Reed Green	Fjord Green
					
Denim Blue	Light Grey	Pebble Grey	Stone Grey	Dust Grey	Onyx Grey
					
Graphite	Indigo	Natural Davos Oak	Beige Grey Lorenzo Oak		

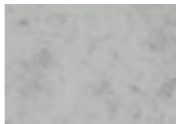
STRETTON & REMO

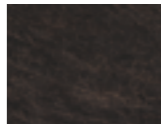
				
White Levanto Marble	Light Chicago Concrete	Dark Chicago Concrete	Cubanite Steelbrush	Cupria Slate

AZURA*

			
Mid Gloss White	Mid Gloss Light Grey	Mid Gloss Dust Grey	Mid Gloss Graphite

*Azura carcasses come in a matt finish

STRETTON

Clean lines meet contemporary style with the Stretton handleless range. Available in a variety of matt, wood, stone and metal effect finishes to suit any modern space.

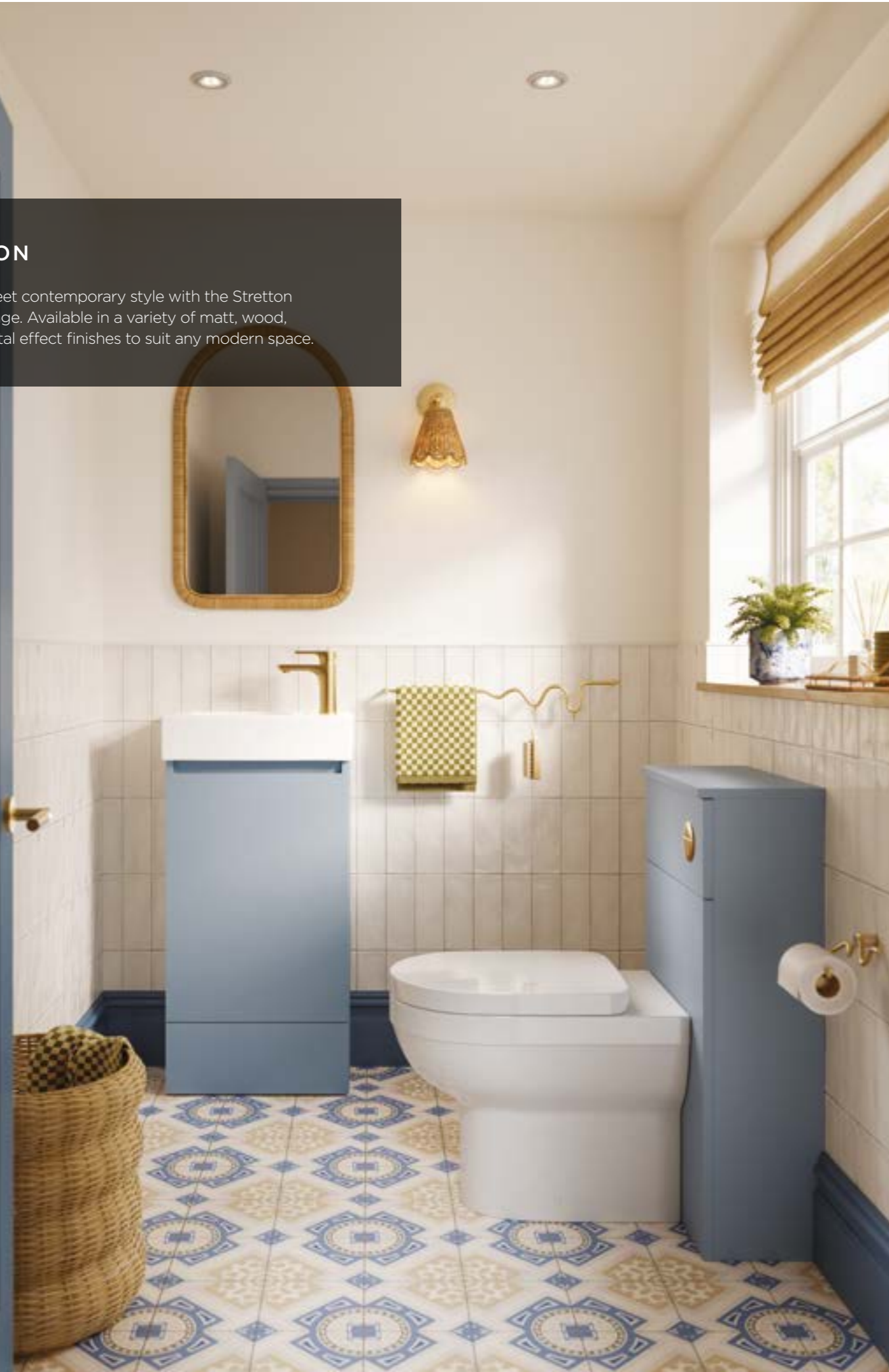

FINISHES



PLAN YOUR SPACE

- Door Colour** Denim Blue
- Cabinet Colour** Denim Blue
- Basin/Worktop** Ceramic Basin
- W/C** Chazey Comfort Height
Back to Wall Pan

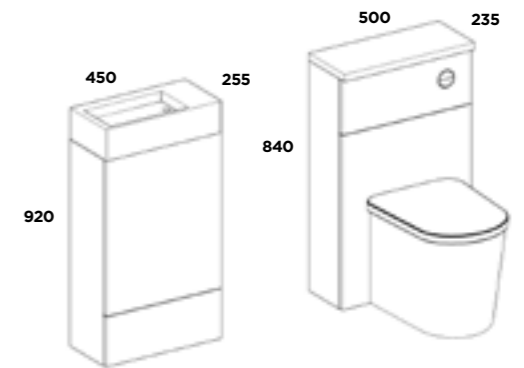



PLAN YOUR SPACE



- Door Colour** Cupria Slate
- Cabinet Colour** Cupria Slate
- Basin** Quadra Ceramic
- W/C** Vision

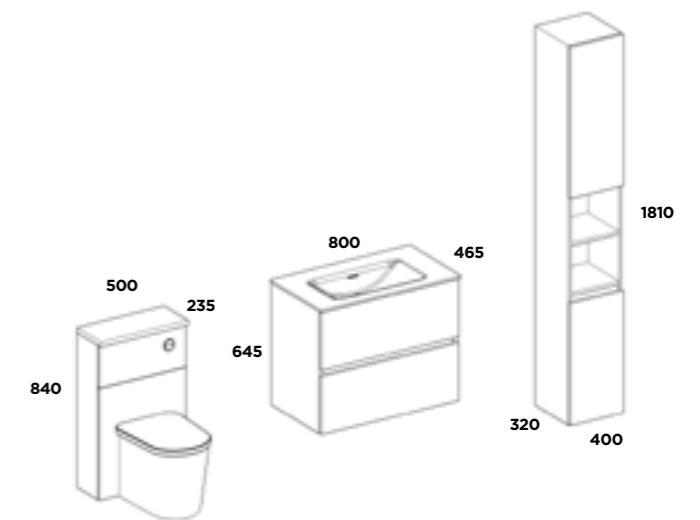



NOVO

The Novo range is the ideal choice for the modern home with its sleek, seamless design style available in an impressive 17 finishes.

FINISHES



PLAN YOUR SPACE



- Door Colour** Rusty Red
- Cabinet Colour** Rusty Red
- Handle** Matt Black Square Knob
- Basin** Langley sit-in basin
- Worktop** Ice Blue 25mm composite
- W/C** Vision

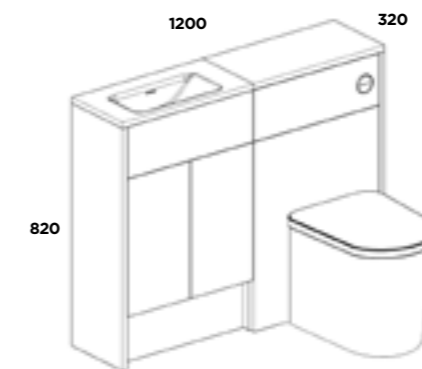



PLAN YOUR SPACE



- Door Colour** Beige Grey Lorenzo Oak
- Cabinet Colour** Beige Grey Lorenzo Oak
- Worktop** Pure Gloss White 22mm Laminate
- Handle** Matt Black 'D' Handle 160mm
- Basin** Emley Sit-in Basin
- W/C** Chezey Comfort Height Back to Wall Pan

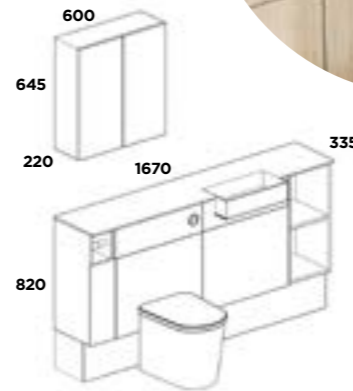

Order with code
MS-55

PLAN YOUR SPACE



- Door Colour** Reed Green
- Cabinet Colour** Reed Green
- Handle** Hampton Brass Knob
- Basin** Unity Slimline Depth Basin Worktop
- W/C** Gilling
- Mirror** Round Mirror 600mm Reed Green





REMO

Make a bold statement in your bathroom with Remo, featured here in White Levanto Marble. Remo doors work equally well as fitted or modular combinations, and the option to mix and match with other finishes provides endless possibilities.

FINISHES

REMO



White Levanto Marble

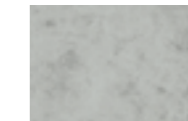

Light Chicago Concrete



Dark Chicago Concrete

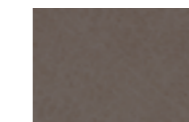

Cubanite Steelbrush

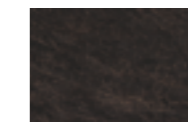

Cupria Slate

PLAN YOUR SPACE



Door Colour	White Levanto Marble
Cabinet Colour	White Levanto Marble
Worktop	White 25mm Solid Composite Worktop
Basin	Acro Sit-On Basin
W/C	Gilling

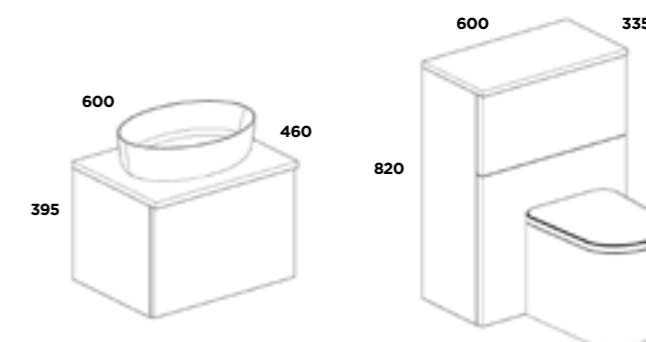



Order with code
MS-38

PLAN YOUR SPACE



- Door Colour** Cupria Slate
- Cabinet Colour** Cupria Slate
- Worktop** White/Grey Cipollino Marble 22mm Laminate
- Handle** Matt Black 'D' Handle
- W/C** Gilling Back-to-Wall
- Mirror** Rectangular Bevelled

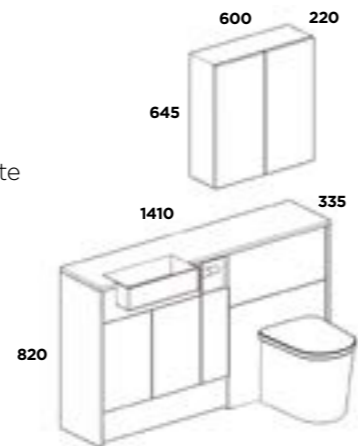

PLAN YOUR SPACE



- Door Colour** Light Chicago Concrete
- Cabinet Colour** Light Chicago Concrete
- Handle** Brushed Aluminium Tab Handle
- Basin** Ergo Fully-Recessed
- Brassware** Aptos Chrome Mono Basin Mixer
- Mirror** Rectangular Bevelled





AZURA

Our Azura mid-gloss range is available in four colours, including Graphite, featured here. The mid-gloss surfaces reflect natural daylight, enhancing the brightness of your bathroom and creating the illusion of additional space.

FINISHES



PLAN YOUR SPACE



Door Colour	Mid Gloss Graphite
Cabinet Colour	Graphite Grey (not mid gloss)
Handle	Brass Hampton Knob
Basin	Verdana Semi-Recessed Basin
W/C	Gilling Back-to-Wall

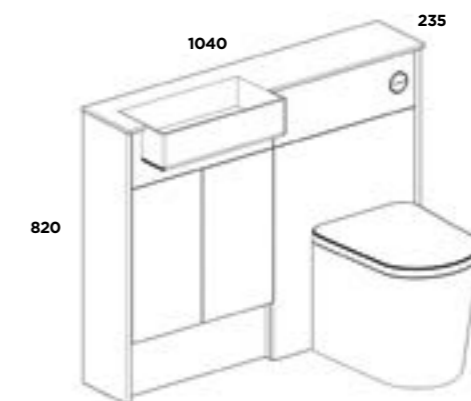



PLAN YOUR SPACE



- Door Colour** Mid Gloss Dust Grey
- Cabinet Colour** Dust Grey (not mid-gloss)
- Worktop** Pure Gloss White 22mm Laminate
- Handle** Matt Black 'D' Handle
- WC** Gilling Back-to-Wall
- Mirror** Round Mirror 600mm Dust Grey

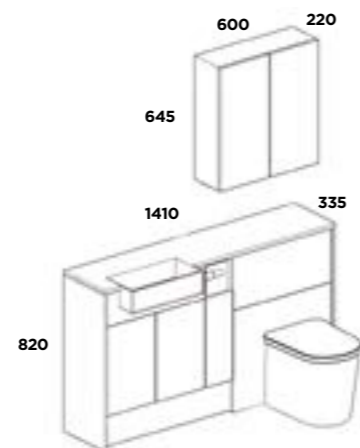

PLAN YOUR SPACE



- Door Colour** Mid Gloss White
- Cabinet Colour** White (not mid-gloss)
- Handle** Pewter/Chrome Lany Knurled Handle
- Basin** Quadra Basin

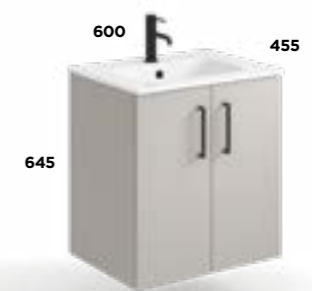



PRICE BAND B

Our five Price Band B ranges Flare, Element, Exel, Inzo and Malbis are available in a wide variety of finishes including high gloss, perfect matt and premium woodgrains. This wide colour palette of options gives you the opportunity to create a truly personalised bathroom.

FINISHES

FLARE



ELEMENT



EXEL



INZO

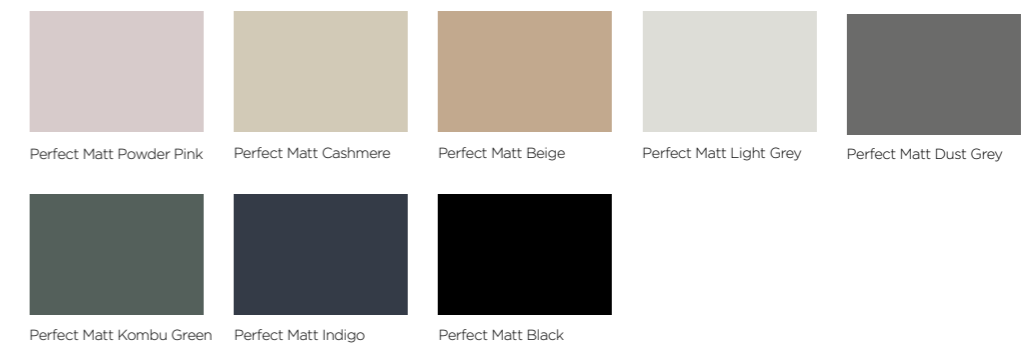

MALBIS

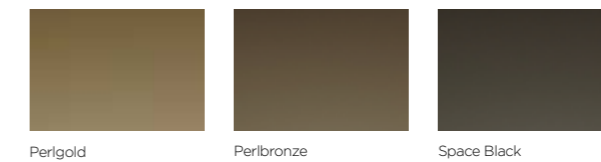



Order with code
MS-36
(BASIN UNIT ONLY)

FLARE

Our Flare range features five striking high gloss finishes for a modern look that will bounce light around your bathroom, adding to a feeling of space.

FINISHES



High Gloss White



High Gloss Cashmere



High Gloss Champagne



High Gloss Light Grey



High Gloss Dust Grey

All colour options come on a colour matched non gloss carcass except High Gloss Champagne which comes on a Stone Grey carcass. Gloss upgrade carcasses have a Dust Grey interior and front edge.

PLAN YOUR SPACE



- Door Colour** High Gloss Dust Grey
- Cabinet Colour** Dust Grey
- Worktop** Terrazzo Galaxy 22mm Laminate
- Handle** Matt Black 'D' Handle
- Basin** Ergo Fully-Recessed
- Mirror** Round Mirror 600mm Dust Grey

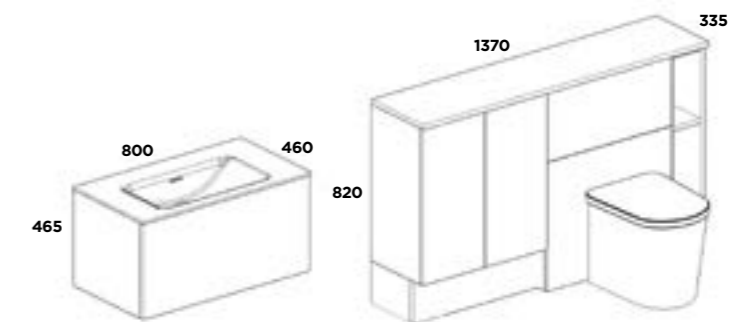



Order with code
MS-52



Order with code
MS-76

PLAN YOUR SPACE



- Door Colour** High Gloss Cashmere
- Cabinet Colour** Cashmere
- Handle** Matt Black 'D' Handle
- Basin/Worktop** Unity All In One Mineral Basin & Worktop



PLAN YOUR SPACE



- Door Colour** High Gloss Light Grey
- Cabinet Colour** Light Grey
- Handle** Matt Black 'D' Handle
- Basin** Ergo





ELEMENT

Texture meets colour with our Element range. Element incorporates a meticulously considered grain pattern producing a look reminiscent of painted timber that's incredibly cost-effective.

FINISHES

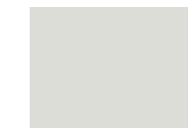

Brushed Light Grey



Brushed Cashmere Grey



Brushed Reed Green



Brushed Dust Grey



Brushed Indigo

PLAN YOUR SPACE



Door Colour	Brushed Dust Grey
Cabinet Colour	Dust Grey
Worktop	White/Grey Cipollino Marble 22mm Laminate
W/C	Gilling
Brassware	Aptos Chrome Mono Basin Mixer
Mirror	Rectangular Bevelled

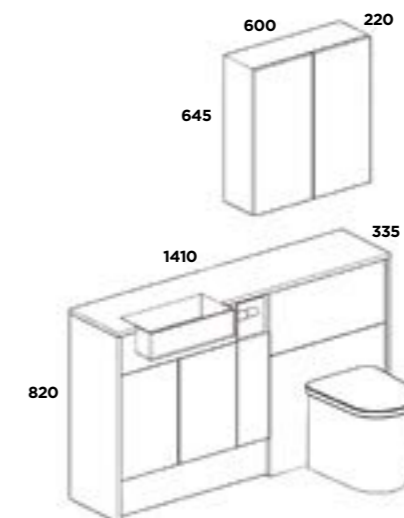



Order our variable vanity unit with code **VB05**



PLAN YOUR SPACE



- Door Colour** Brushed Reed Green
- Cabinet Colour** Reed Green
- Handle** Satin Brass Milano 'D' Handle

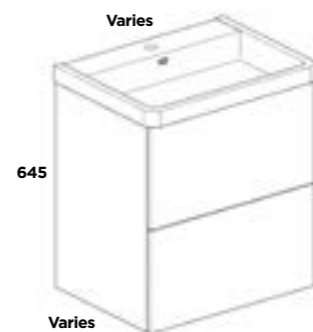

Order with code **MS-51**

PLAN YOUR SPACE



- Door Colour** Brushed Cashmere
- Cabinet Colour** Cashmere
- Handle** Knurled Black Knob
- Basin** Cloakroom
- Mirror** Round Mirror 600mm Cashmere





EXEL

Exel is available in five woodgrain finishes. Choose to create a Scandi look in White Halifax Oak or go warmer or darker with the other options.

FINISHES



White Halifax Oak



Light Natural Casella Oak



Natural Halifax Oak



Tobacco Halifax Oak



Marone Casella Oak

PLAN YOUR SPACE



Door Colour	Marone Casella Oak
Cabinet Colour	Graphite Grey
Worktop	Pure Gloss White 22mm Laminate
Handle	Brass Hampton Knob
Basin	Verdana Semi-Recessed
W/C	Gilling
Mirror	Round Mirror 600mm Graphite Grey

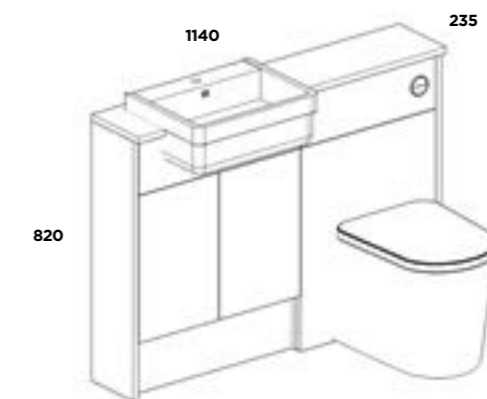



Order with code
MS-52



Order with code
MS-36
(BASIN UNIT ONLY)

PLAN YOUR SPACE



- Door Colour** Natural Halifax Oak
- Cabinet Colour** Light Grey
- Handle** Matt Black 'D' Handle
- Basin/Worktop** Unity All In One Mineral Basin & Worktop



PLAN YOUR SPACE



- Door Colour** Light Natural Casella Oak
- Cabinet Colour** Light Natural Casella Oak (Upgrade)
- Worktop** Terrazzo Galaxy 22mm Laminate
- Handle** Matt Black 'D' Handle
- Basin** Ergo Fully-Recessed

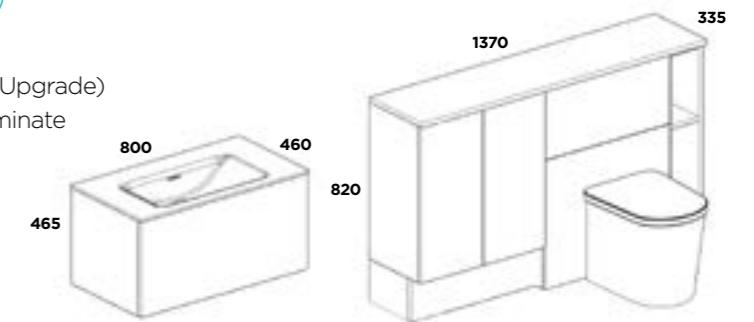



INZO

With its high quality matt finish, Inzo sets itself apart in bathroom design. The matt finish prevents unsightly fingerprints on the surfaces and considerably reduces the amount of cleaning required.

FINISHES



PLAN YOUR SPACE



Door Colour	Perfect Matt Kombu Green
Cabinet Colour	Perfect Matt Kombu Green (Upgrade)
Worktop	Seal Rocks Stone 22mm Laminate
Handle	Brushed Aluminium Tab Handle
Basin	Molveno Sit-On
W/C	Gilling
Mirror	Mirrored Unit

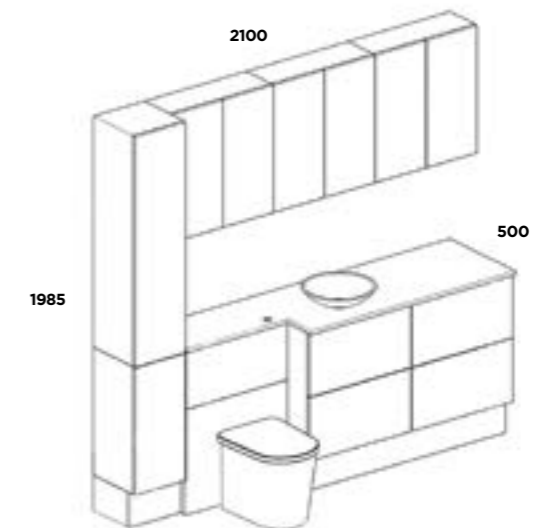



Order with code
MS-35
(BASIN UNIT ONLY)

PLAN YOUR SPACE



- Door Colour** Perfect Matt Powder Pink
- Cabinet Colour** Perfect Matt Powder Pink (Upgrade)
- Worktop** Carrara Marble 22mm Laminate
- Handle** Brushed Aluminium Tab Handle
- Basin** Vision Semi-Recessed
- Mirror** Rectangular Bevelled

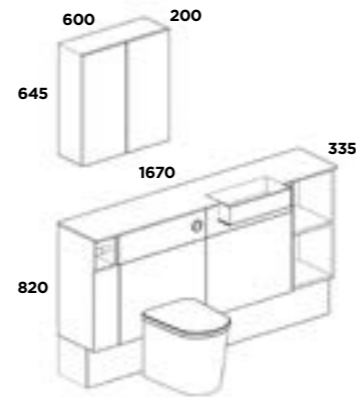

PLAN YOUR SPACE



- Door Colour** Perfect Matt Indigo
- Cabinet Colour** Perfect Matt Indigo (upgrade)
- Handle** Polished Chrome Bar Handle
- Basin** Ergo Modular Basin
- Mirror** Round Mirror 600mm Indigo

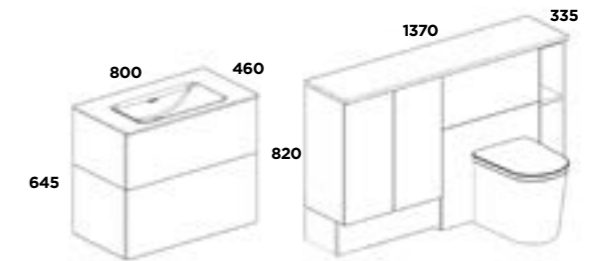



MALBIS

The Metallic finishes of our Malbis range create a luxurious finish to both the eye and the touch in an eco-friendly material.

FINISHES



Perlgold



Perlbronze



Space Black

PLAN YOUR SPACE



- Door Colour** Perlbronze
- Cabinet Colour** Perlbronze (Upgrade)
- Handle** Matt Black Tunbridge 'D' Handle
- Basin** Quadra Modular
- W/C** Vision

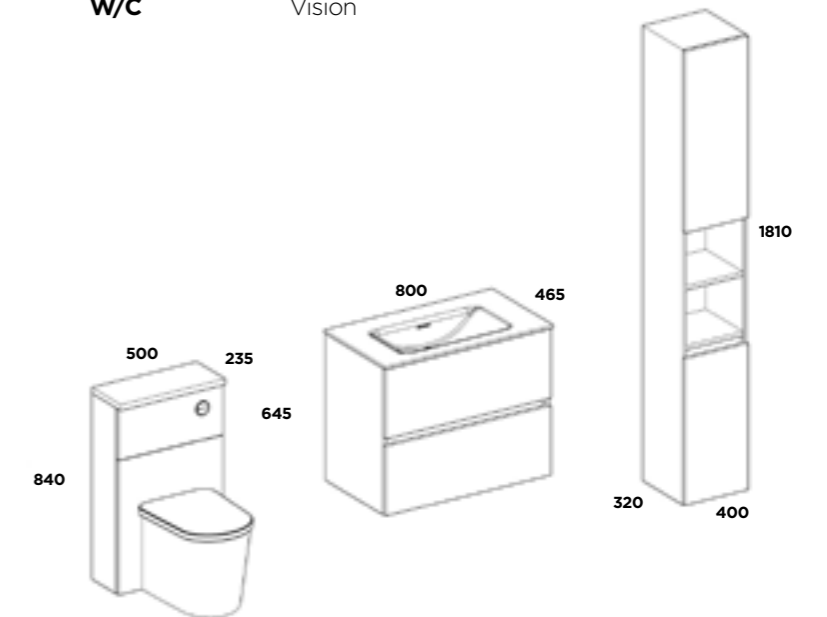



PLAN YOUR SPACE



- Door Colour** Space Black
- Cabinet Colour** Space Black (Upgrade)
- Handle** Brass Hampton Knob
- Basin** Cloakroom

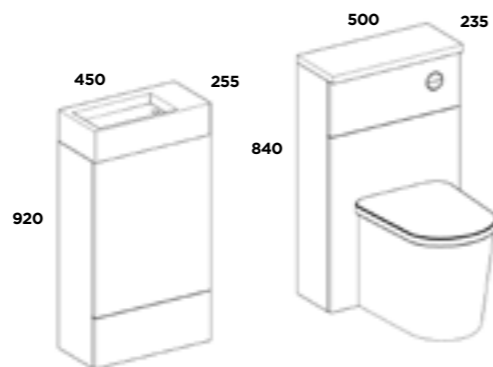

PLAN YOUR SPACE



- Door Colour** Perlgold
- Cabinet Colour** Light Grey
- Worktop** Copper Fleck 25mm Solid Composite
- Handle** Brushed Aluminium Tab Handle
- Basin** Molveno Sit-On
- W/C** Gilling
- Mirror** Mirrored Unit

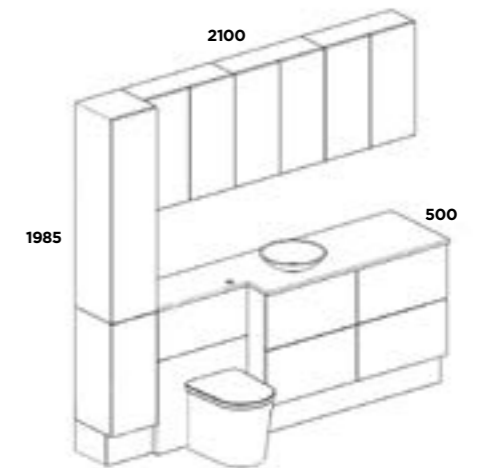

PRICE BAND C

The 1891 real wood collection of fitted bathroom furniture from Ellis is perfect in all home settings for a timeless look. Ellis fitted furniture works well in main bathrooms, en-suites or cloakrooms, and can adapt to any area to maximise space. The 1891 collection is beautifully crafted and is available in four stunning door styles and a pallet of 30 on-trend paint colours. Our paints are water based to reduce our impact on the environment without compromising on quality.

PAINT FINISHES

LIGHTS	GREYS	WARM NEUTRALS	BLUE/GREENS	DARKS	STATEMENT
Pure White	Dove Grey	Fossil	Soft Moss	Brick	Blush Pink
Stone White	Cool Grey	Leather	Frosted Sage	Fresh Aubergine	Dusky Pink
Seashell White	Thistle	Otter	Tranquil Thyme	Copse	Terra Red
	Basalt Grey		Stormy Sky	Inky Indigo	Tuscan Yellow
			Classic Denim	Dark Mauve	Sea Green
			Padstow Blue	Charcoal	Salcombe Blue
				Black	Admiral

1891 DOOR STYLES

Kensington	Hampshire	Hepworth	Rosedale	Elevate



Order with code
MS-2



Order with code
MS-10

KENSINGTON

The intricate door detail in Kensington offers a classic design for a timeless bathroom look and includes stunning finishing touches such as a bath panel with design detail.



30
COLOURS
AVAILABLE

PLAN YOUR SPACE



- Door Colour** Tranquil Thyme
- Cabinet Colour** Beige Grey Lorenzo Oak
- Worktop** Beige Grey Lorenzo Oak 22mm Laminate
- Handle** Nickel Knurled 'D' Handle
- Basin** Molveno Sit-On
- Brassware** Evoque Mono Basin Mixer
- Mirror** Kensington Tranquil Thyme





PLAN YOUR SPACE



- Door Colour** Pure White
- Cabinet Colour** Platinum White
- Worktop** Natural Halifax Oak 22mm Laminate
- Handle** Chrome Monmouth Knob
- Basin** Vision Semi-Recessed

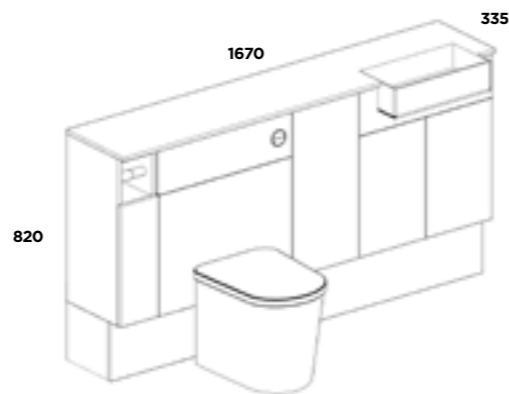

PLAN YOUR SPACE



- Door Colour** Seashell White
- Cabinet Colour** Natural Carini Walnut
- Handle** Monmouth Chrome Knob
- Basin** Molveno Sit-On
- Brassware** Evoque Mono Basin Mixer





Order with code
MS-1

ROSEDALE

Rosedale is a beautiful modern take on the shaker door with its narrow frame. Choose from our range of 30 paint colours to create a distinctive bathroom design with minimal fuss.



30
COLOURS
AVAILABLE

PLAN YOUR SPACE



Door Colour	Dark Mauve
Cabinet Colour	Natural Carini Walnut
Worktop	Softstone 22mm Laminate
Handle	Brushed Brass Plain Knob
Basin	Molveno Sit-On





PLAN YOUR SPACE



- Door Colour** Padstow Blue
- Cabinet Colour** Natural Carini Walnut
- Worktop** Carrara White 25m Composite
- Handle** Chrome Monmouth Knob
- Basin** Molveno Sit-On
- Brassware** Evoque Mono Basin Mixer



PLAN YOUR SPACE



- Door Colour** Thistle
- Cabinet Colour** Natural Carini Walnut
- Worktop** White/Grey Cipollino Marble 22mm Laminate
- Handle** Chrome Monmouth Knob
- Basin** Vision Semi-Recessed
- W/C** Evoque back to wall WC

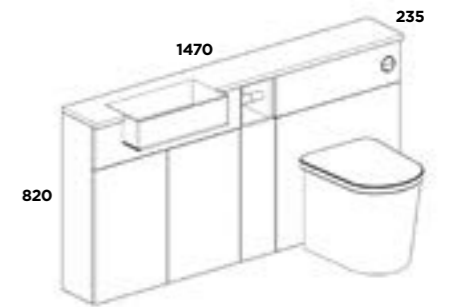



HAMPSHIRE

Oozing elegance and luxury, Hampshire is part of our real wood 1891 Collection, manufactured from premium solid timbers and with a beautifully crafted in-frame design that will never go out of fashion.



30
COLOURS
AVAILABLE



PLAN YOUR SPACE



Door Colour	Copse
Cabinet Colour	Natural Carini Walnut
Worktop	Softstone 22mm Laminate
Basin	Molveno Sit-On
Mirror	Round Mirror 600mm Cashmere



Order with code
MS-3



PLAN YOUR SPACE

- Door Colour** Inky Indigo
- Cabinet Colour** Natural Carini Walnut
- Worktop** Softstone 22mm Laminate
- Basin** Evoque Semi-Recessed
- W/C** Evoque

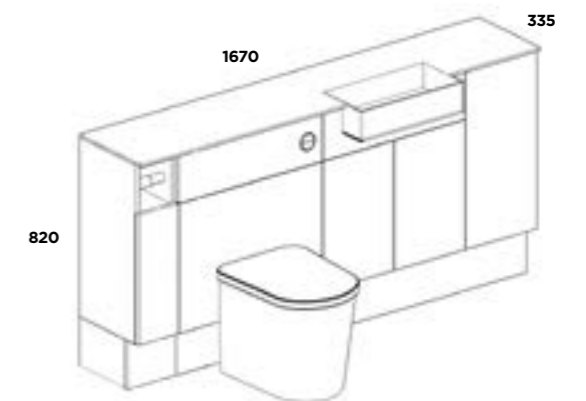



HEPWORTH

Hepworth is a true bathroom classic with its shaker style design and is equally at home in a contemporary or period bathroom setting.



30
COLOURS
AVAILABLE



PLAN YOUR SPACE



- Door Colour** Fresh Aubergine
- Cabinet Colour** Natural Carini Walnut
- Worktop** Natural Halifax Oak 22mm Laminate
- Handle** Chrome Monmouth Knob
- Basin** Acro Sit-On
- Mirror** Shaker Style Painted

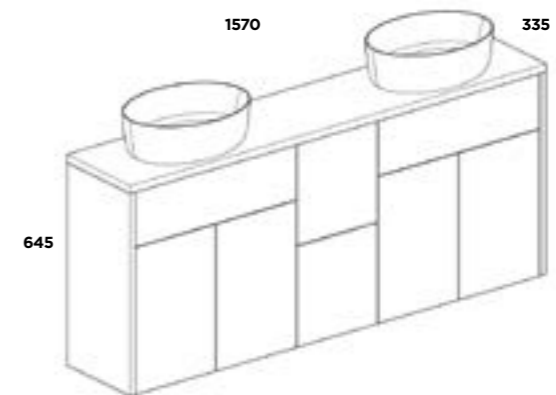



PLAN YOUR SPACE



- Door Colour** Charcoal
- Cabinet Colour** Natural Carini Walnut
- Worktop** Natural Halifax Oak 22mm Laminate
- Handle** Chrome Monmouth Knob
- Basin** Acro Sit-On
- W/C** Evoque
- Mirror** Shaker Style Painted

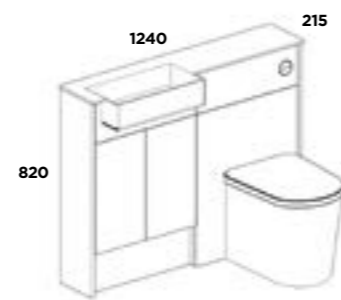

*Natural wooden lacquered toilet seat is manufactured from different material to worktops and furniture so will not be an identical colour match.



PLAN YOUR SPACE



- Door Colour** Classic Denim
- Cabinet Colour** Beige Grey Lorenzo Oak
- Worktop** Beige Grey Lorenzo 22mm Laminate
- Handle** Chrome Monmouth Knob
- Basin** Evoque Semi-Recessed
- Brassware** Evoque Mono Basin Mixer
- Mirror** Shaker Style Painted

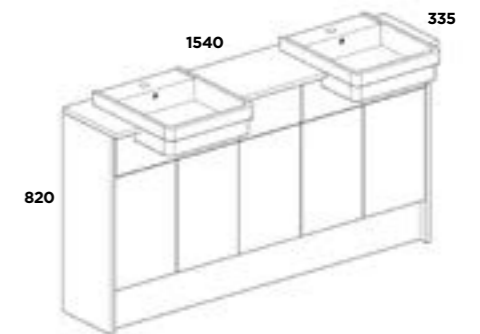



ELEVATE

Elevate features an elegant painted real wood door front in five distinctive paint colours, each colour matched with paint effect cabinets for a perfect match.

FINISHES

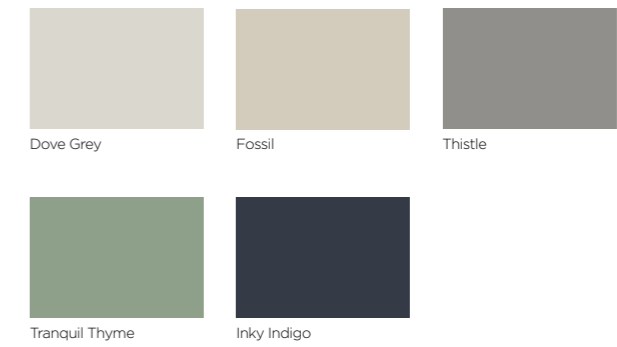

PLAN YOUR SPACE



Door Colour	Fossil
Cabinet Colour	Brushed Cashmere
Worktop	Natural Halifax Oak 22mm Laminate
Handle	Matt black 'D' handle
Basin	Vision Semi-Recessed
W/C	Evoque

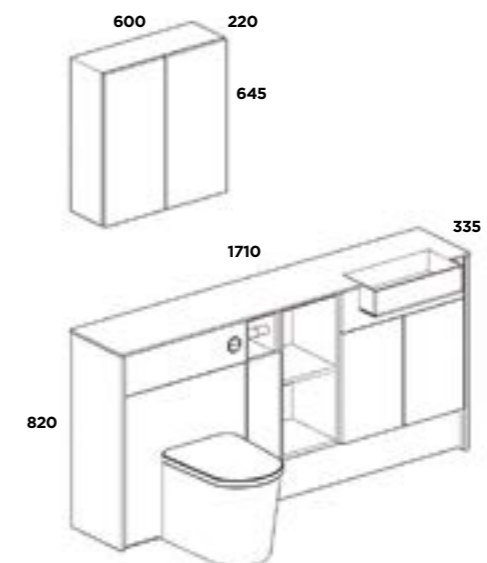



FINISHING TOUCHES & TECHNICAL SPECIFICATION

Modern Dark
Mauve Finish



Woodgrain
Texture

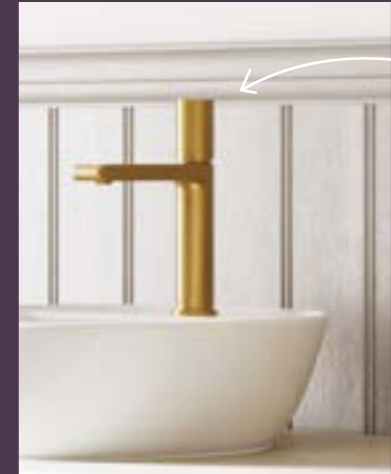

Contemporary
tap



Softstone
22mm Laminate

COLOUR OPTIONS

STRETTON & NOVO



STRETTON & REMO

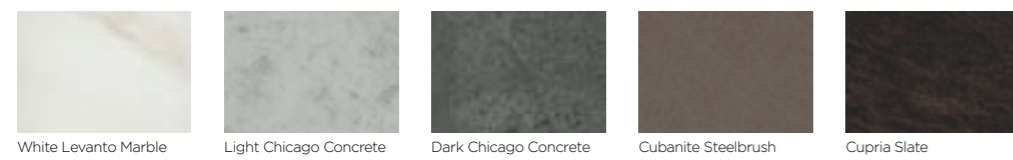

AZURA*



*Azura carcasses come in a matt finish

In Price Band A* all ranges come on a matching colour carcass.

All price band B finishes come with a complementary or contrasting carcass colour as shown below. You can also choose to upgrade your carcass for a colour and texture matched carcass.

FLARE



All colour options come on a colour matched non gloss carcass except High Gloss Champagne which comes on a Stone Grey carcass. Gloss upgrade carcasses have a Dust Grey interior and front edge.

ELEMENT

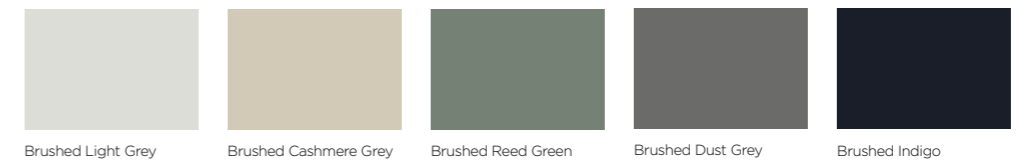

All colour options come on a colour matched non woodgrain carcass.

EXEL

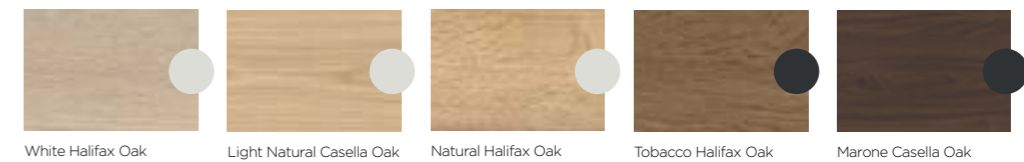

All Exel finish options come on a contrasting Light Grey or Graphite Grey carcass.

INZO

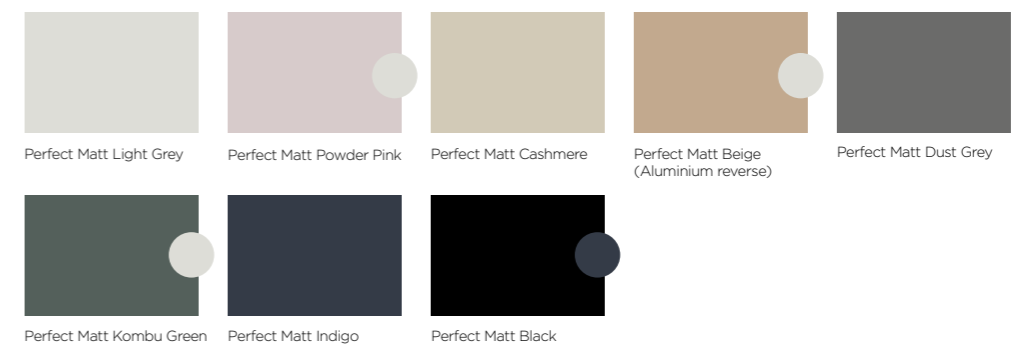

Light Grey, Cashmere, Dust Grey and Indigo come on a colour matched non matt carcass. Black comes on a non matt Graphite carcass. Kombu Green, Powder Pink and Beige come on a Light Grey carcass.

MALBIS

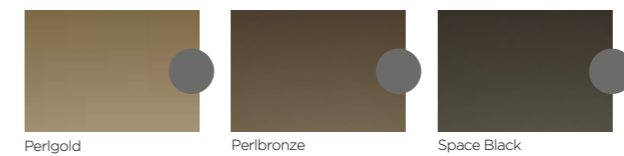

All Malbis finishes come on a contrasting Dust Grey carcass. Malbis upgrade carcasses have a Dust Grey interior and front edge.

1891 COLOUR OPTIONS

Kensington, Hampshire, Hepworth & Rosedale are available in all 30 colours below and are available on a wide choice of complementary carcass colours. Elevate is available in 5 contemporary colours with a near matching carcass.

1891 DOOR STYLES

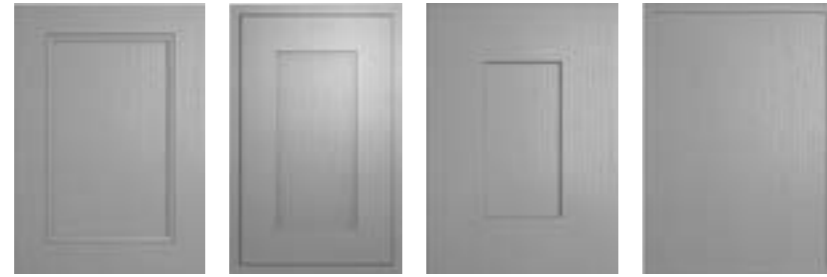

Kensington Hampshire Hepworth Rosedale

PAINT FINISHES

LIGHTS

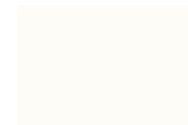

Pure White

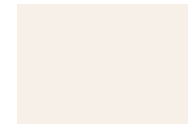

Stone White

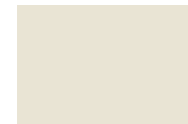

Seashell White

GREYS



Dove Grey*



Cool Grey



Thistle*



Basalt Grey

WARM NEUTRALS



Fossil*



Leather



Otter

BLUE/GREENS

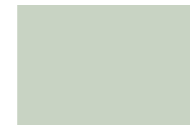

Soft Moss



Frosted Sage



Tranquil Thyme*



Stormy Sky



Classic Denim



Padstow Blue

DARKS



Brick



Fresh Aubergine



Copse



Inky Indigo*



Dark Mauve



Charcoal

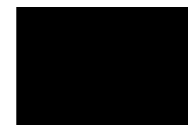

Black

STATEMENT



Blush Pink



Dusky Pink



Terra Red



Tuscan Yellow



Sea Green



Salcombe Blue



Admiral

*Comes with a near match colour carcass

ELEVATE



Elevate



Dove Grey



Fossil



Thistle



Tranquil Thyme



Inky Indigo

ELEVATE
5 colours with a matching carcass.

*Elevate uses an MFC carcass, so you may notice some colour variation between this and the painted finish of the door.

CARCASS COLOURS

PLAIN COLOURS

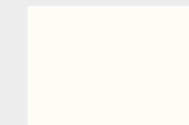

Platinum White

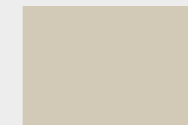

Cashmere

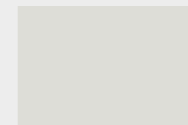

Light Grey

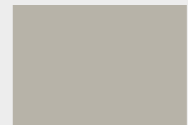

Pebble Grey



Stone Grey

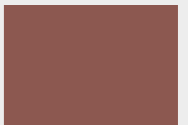

Rusty Red



Dust Grey



Fjord Green



Reed Green

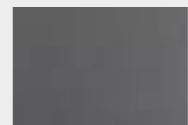

Onyx Grey



Indigo Blue



Graphite Grey

WOODGRAINS



Natural Davos Oak













Beige Grey Lorenzo Oak















Natural Carini Walnut

KNOB HANDLES

-  Chrome Barrel Knob [HA.55](#)
-  Chrome Monmouth Knob [HA.283](#)
-  American Copper Monmouth Knob [HA.294](#)
-  Chrome Square Knob [HA.17](#)
-  Black Nickel Calgary Knob [HA.404](#)
-  Satin Brass Camden Rectangular Knob [HA.407](#)
-  Matt Black Square Knob [HA.303](#)
-  Knurled Black Knob [HA.338](#)
-  Knurled Brushed Nickel Knob [HA.339](#)
-  Brass Hampton Knob [HA.340](#)

-  Polished Nickel Caesar Knob [HA.547](#)
-  Satin Brass Caesar Knob [HA.549](#)
-  Antique Brass Caesar Knob [HA.550](#)
-  25mm Brushed Brass Plain Knob [HA.570](#)
-  25mm Brushed Nickel Plain Knob [HA.572](#)
-  25mm Matt Black Plain Knob [HA.571](#)
-  25mm Chrome Knob [HA.569](#)

D HANDLES

-  Chrome Tunbridge D Handle [HA.568](#)
-  Brushed Satin Nickel Tunbridge D Handle [HA.567](#)
-  Satin Brass Tunbridge D Handle [HA.566](#)
-  Matt Black Tunbridge D Handle [HA.565](#)
-  Satin Brass Camden D Handle 160mm [HA.406](#)
-  Chrome Camden D Handle 160mm [HA.405](#)
-  Pewter/Chrome Lany Knurled Handle 160mm [HA.408](#)
-  Knurled Black D Handle 128mm Centres [HA.336](#)
-  Knurled Brushed Nickel D Handle 128mm Centres [HA.337](#)
-  Matt Black 'D' Handle 160mm [HA.322](#)
-  Satin Brass Milano D Handle 160mm [HA.402](#)
-  Chrome Square D Handle [HA.302](#)
-  Nickel Square D Handle [HA.320](#)

TRIM HANDLES

-  Brushed Aluminium 40mm Tab Handle [HA.318](#)
-  Brushed Aluminium 200mm Tab Handle [HA.313](#)



22MM POSTFORMED LAMINATE COLOURS

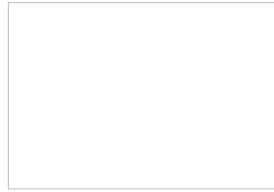

Pure Gloss White

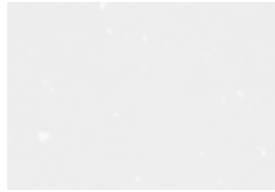

White Sparkle

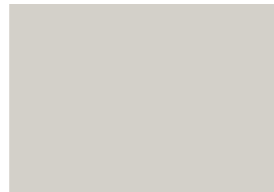

Light Grey



Carrara Marble



Softstone



Botticino



White / Grey Cipollino Marble



Greige Cracked Marble

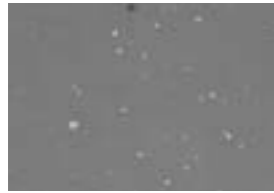

Grey Sparkle



Onyx Grey

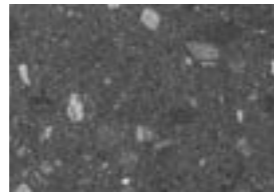

Terrazzo Galaxy



Ephesus Marble



Seal Rocks Stone



Beige Grey Lorenzo Oak



Natural Halifax Oak

25MM SOLID COMPOSITE COLOURS

PRICE BAND 1

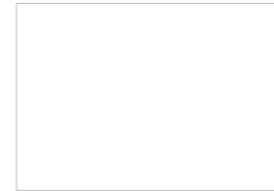

White

PRICE BAND 2



Ice Blue



Ice Crystal



Grey Crystal



Peak Stone

PRICE BAND 3

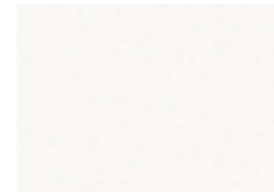

Sparkling White

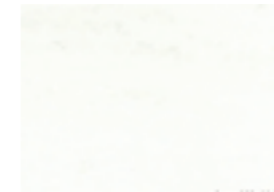

Marble Wash



Blue Venato



Travertine Haze



Copper Fleck



Grey Storm



Chalk Venato



Carrara White

PRICE BAND 4



Calcutta White

Slimline for 220mm deep furniture

Semi-Recessed Basins



Verdana

- 450 x 245 x 142
Cast Marble
- Mineralcast gloss white
 - Right-hand monobloc tap position only
 - Includes an overflow outlet

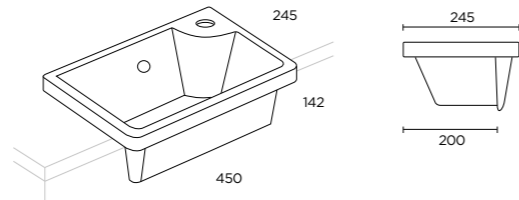

BA22



Vision

- 550 x 375 x 150
Ceramic
- Ceramic gloss white
 - Right-hand monobloc tap position only
 - Includes an overflow outlet

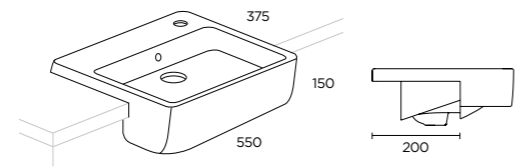

BA16

Sit-in Basins



Langley

- 510 x 235 x 147
610 x 235 x 147
- Cast Marble Gloss White
 - One side tap hole, reversible for left or right fitting
 - Includes an overflow outlet

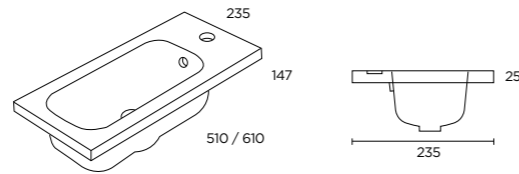

BA24
BA25



Emley

- 610 x 360 x 175
- Cast Marble Gloss White
 - Central monobloc tap position
 - includes an offset overflow outlet

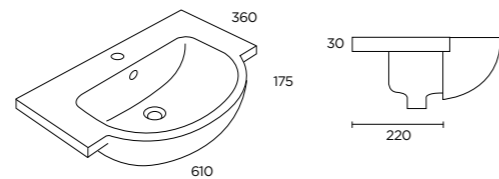

BA28

Medium Depth Basins for 320mm deep furniture

Semi-Recessed Basins



Sonning

- 560 x 470 x 160
Ceramic
- Ceramic gloss white
 - Central monobloc tap position
 - Includes an overflow outlet

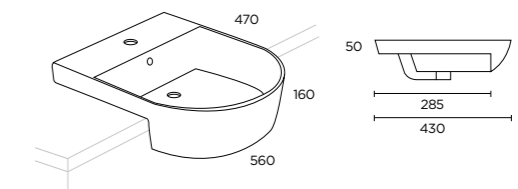

BA23



Vision

- 550 x 460 x 160
Ceramic
- Ceramic gloss white
 - Central monobloc tap position
 - Includes an overflow outlet

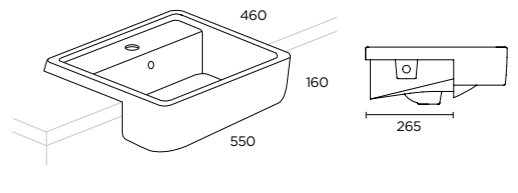

BA15



Evoque (1 tap hole)

- 550 x 442 x 193
Ceramic
- Ceramic gloss white
 - Central monobloc tap position
 - Includes an overflow outlet

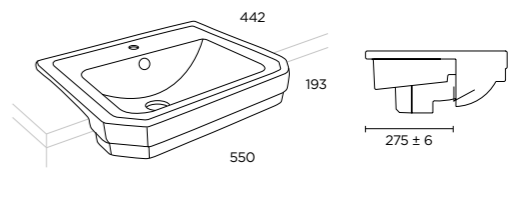

BA17

Sit-in Basins



Langley

- 510 x 355 x 147
610 x 355 x 147
- Cast Marble Gloss White
 - Central monobloc tap position
 - includes an offset overflow outlet

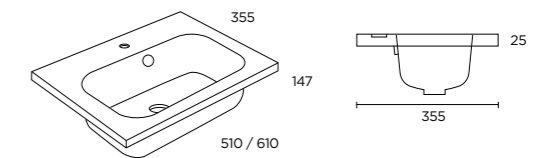

BA26
BA27



Emley

- 610 x 460 x 175
- Cast Marble Gloss White
 - Central monobloc tap position
 - includes an offset overflow outlet

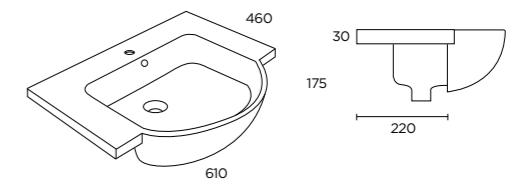

BA29

SHALLOW (355 / 360MM DEPTH)



Ergo Shallow

605 x 355 x 130
805 x 355 x 130

- Mineralcast gloss white
- Offset / corner tap position
- Includes an overflow outlet

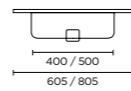
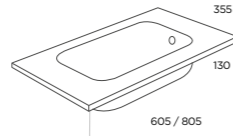

BA30
BA33



Quadra Shallow

610 x 360 x 135
810 x 360 x 135

- Ceramic gloss white
- Central monobloc tap position
- Includes an overflow outlet

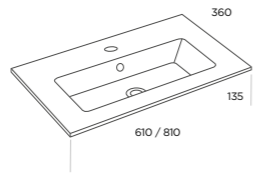

BA85
BA86

MEDIUM DEPTH (460MM DEPTH)



Ergo

605 x 460 x 143
805 x 460 x 143

Cast Marble

- Mineralcast gloss white
- Central monobloc tap position
- Includes an overflow outlet

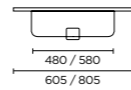
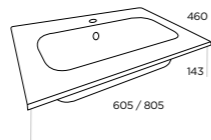

BA09
BA10



Quadra

610 x 460 x 155
810 x 460 x 155

Ceramic

- Ceramic gloss white
- Central monobloc tap position
- Includes an overflow outlet

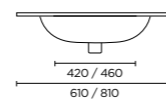
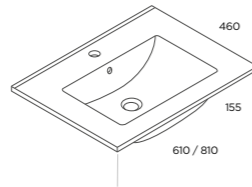

BA81
BA84

CLOAKROOM BASIN



Cloakroom (tap hole to the right)

450 x 260 x 100
Ceramic

- Ceramic gloss white
- Right-hand tap position only
- Without overflow outlet

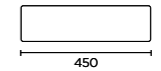
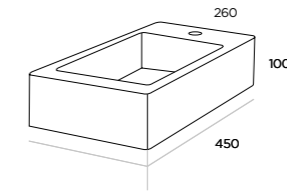

BA45

SIT-ON BASINS



Radley Fluted

360mm Diameter

- Groove fluted ceramic basin
- Without tap position
- Without overflow outlet

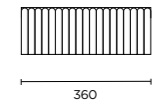
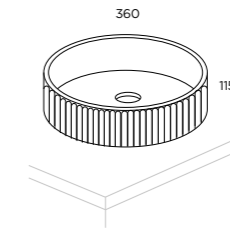

BA34

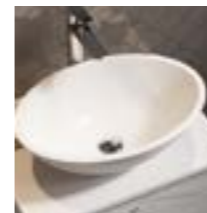

Acro

500 x 350 x 160
Cast Marble

- Mineralcast gloss white
- Without tap position
- Without overflow outlet

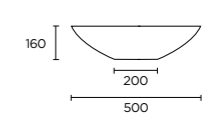
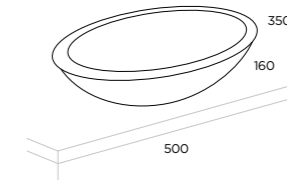

BA19



Molveno

403 x 403 x 120
Ceramic

- Ceramic gloss white
- Central monobloc tap position
- Without overflow outlet

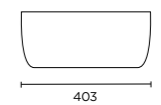
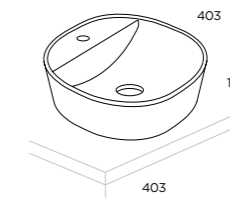

BA20

Unity Basin Furniture Design

The Unity basin requires a 600mm basin unit to be positioned at one end of the design to accommodate the basin placement.

Unity Basin Sizes

All Unity basins are 1558mm wide and come in two depths:

Medium depth

Slimline depth

The basins are designed to be cut to the required length on-site using regular woodworking tools, making them adaptable to various bathroom layouts.

Unity Basin Waste and Overflow

The Unity basin features an integrated overflow, ensuring quick installation and a hassle-free experience over its lifespan.

Unity Basin Tap Positions

The underside of the Unity basins includes tap hole templates in the centre, left, and right positions, allowing flexibility in tap placement.

If a wall-mounted tap is preferred, the pre-marked holes can be ignored.

Dimensions

W x D x H (mm)

Unity Slimline Depth Left Hand Basin Worktop

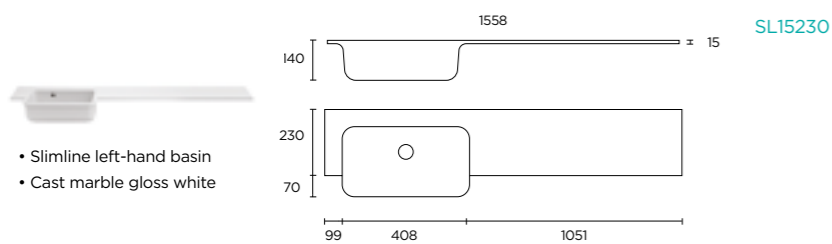

Unity Slimline Depth Right Hand Basin Worktop

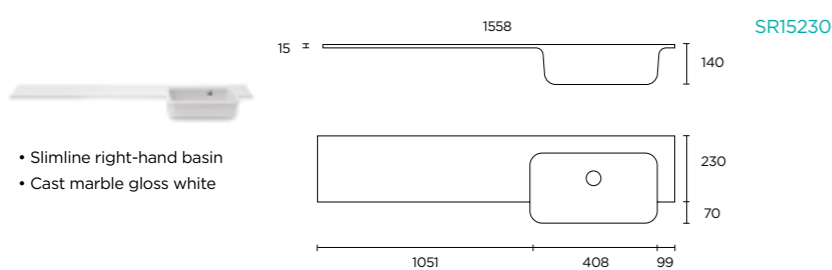

Unity Finishing Kits

To refinish any cut edges that will be visible, two types of finishing kits are available. These should be ordered at the same time as the basin:

Touch-Up Kit - KITLUC1

A simple-to-use system designed to restore a consistent polished finish to any cut edge.

Gelcoat High-Gloss Finishing Kit - 5120001

An advanced finishing system for achieving a high-gloss factory finish.

Installation Instructions

Full installation instructions are provided with every Unity basin to ensure a smooth installation process, matching the sleekness of the worktop finish.

Dimensions

W x D x H (mm)

Unity Medium Depth Left Hand Basin Worktop

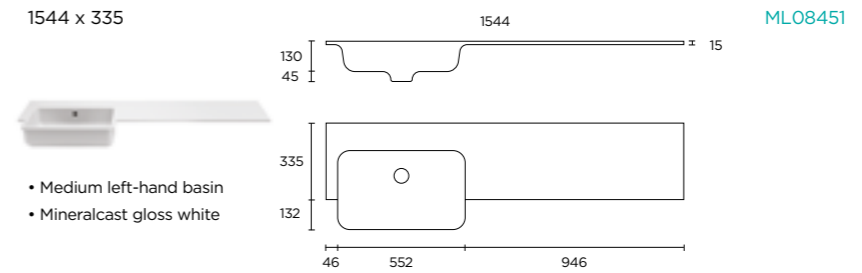

Unity Medium Depth Right Hand Basin Worktop

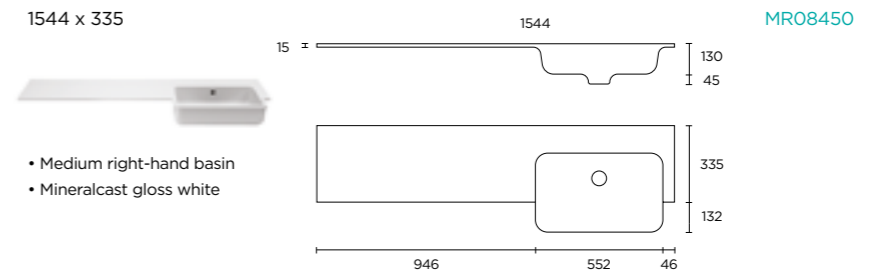

Finishing Kits

Gelcoat & catalyst high gloss finishing kit

Suggested for use if a high gloss finish is required after cutting



5120001

Touch up kit





To smooth and repolish after cutting to worktop

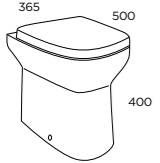
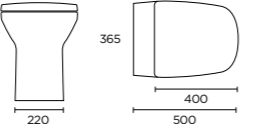
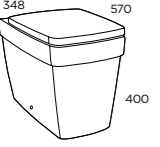
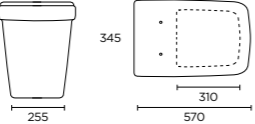

KITLUC1

Ellis WC Range

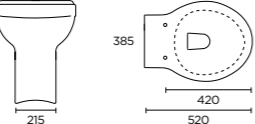
- The Ellis range of WCs is designed to work perfectly with our cabinetry, offering both classic and contemporary designs, including wall-hung and comfort-height options.
- Toilet seats are sold separately and include a painted option to match our 30 real wood paint colours.
- Guarantee on Ceramic Basins and WCs is 10 Years (Exc. BA81 & BA84 which is 2 Years). Toilet Seat Guarantee is 1 Year.

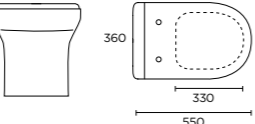
	Dimensions W x D x H (mm)		Code
	Gilling 365 x 500 x 400		PA16
	Vision 348 x 570 x 400		PA07
	Evoque 385 x 520 x 410		PA03
	Chazey Comfort Height 360 x 550 x 445		PA15

Back to Wall WC's (excluding soft close seat - available to order separately)

Gilling

365 x 500 x 400

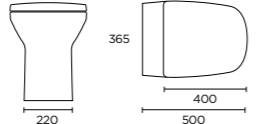

PA16

Vision

348 x 570 x 400

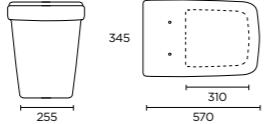

PA07

Evoque

385 x 520 x 410

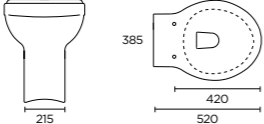

PA03

Chazey Comfort Height

360 x 550 x 445

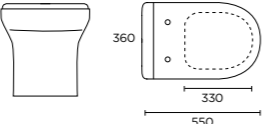

PA15

Cisterns

Comfort Height Cistern

Chrome effect round flush button included in cistern.

AX98

Prices include VAT (20%)

Dimensions
W x D x H (mm)

Code

Price

Plastic Soft-Close Toilet Seats

Gilling

365 x 400 x 37

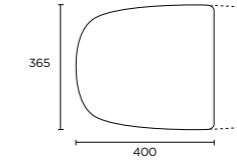

TS16

Vision

368 x 450 x 37

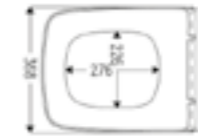

TS09

Chazey

420 x 365 x 35

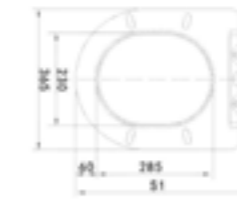

TS15

Wooden Soft-Close Toilet Seats

Evoque in Pure White

374.6 x 424 x 54.7

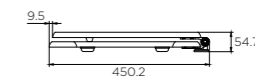
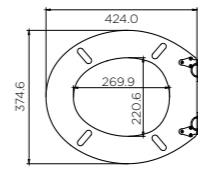

TS10

Evoque in Universal Lacquered Oak

374.6 x 424 x 54.7

(Lacquered oak toilet seat is manufactured from different material to worktops and furniture so will not be an identical colour match)

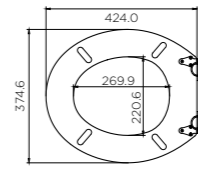





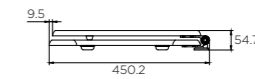
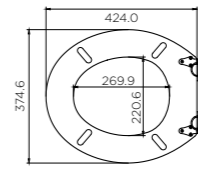

TS12

Evoque in 30 Ellis Paint Colours









374.6 x 424 x 54.7



TS11

Description	Code
Flush Buttons	
 Round Flush Button 75mm Black	FL03MB
 Round Flush Button 75mm Brass	FL03BB
 Square Flush Button 72mm Chrome	FL04CH
 Square Flush Button 72mm Black	FL04MB
 Square Flush Button 72mm Brass	FL04BB
 Basin Overflow Ring Black	OVO1BL
 Basin Overflow Ring Brushed Brass	OVO2BB

The Ellis brassware range feature the popular styles and colours that any bathroom needs, all at great competitive price points. The Leeming and Aptos ranges come with a complementary slotted click clack waste. Alternatively the Evoque basin mixer comes with a pop up waste for a more classic alternative

Dimensions W x D x H (mm)	Code	Price
 Mono Basin Mixer Taps Evoque incl. Pop-up Waste	TP31	
 Leeming Chrome incl. click clack waste (slotted)	TP36CH	
 Leeming Matt Black incl. click clack waste (slotted)	TP36MB	
 Leeming Brushed Brass incl. click clack waste (slotted)	TP36BB	
 Aptos Chrome incl. click clack waste (slotted)	TP37CH	
 Aptos Matt Black incl. click clack waste (slotted)	TP37MB	
 Aptos Brushed Brass incl. click clack waste (slotted)	TP37BB	
Please note that the wastes are the same colour as the tap		
 Click-Clack Waste Ellis Chrome (branded)	TP05	

CABINET SIZES AND OPTIONS

Whether you're looking for a fully fitted wall-to-wall style bathroom design, or a more modular style, our wide range of cabinet sizes and shapes will enable you to bring your ideas to life. Choose from our fitted cabinet range or our modular cabinet range, or mix them together in your own style. Currently very popular is our 1891 collection, available in an array of natural and painted colourways to suit your interior style.

TALL AND WALL UNITS

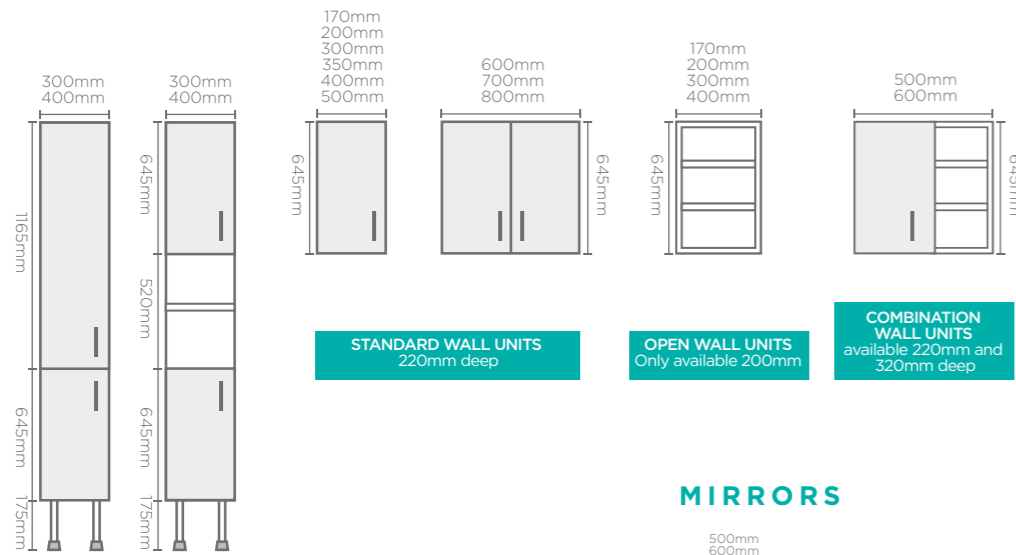

TALL UNITS
available 320mm and 220mm deep

MIRRORS

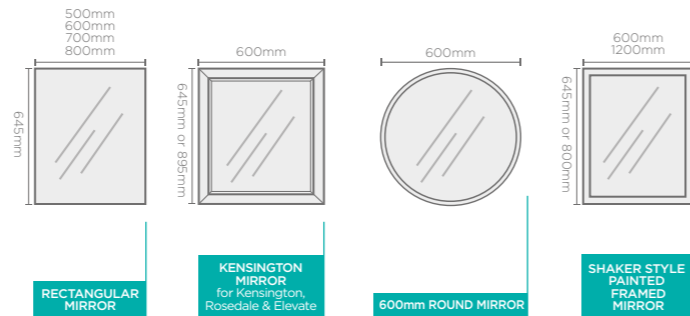

BASE AND COUNTERTOP UNITS

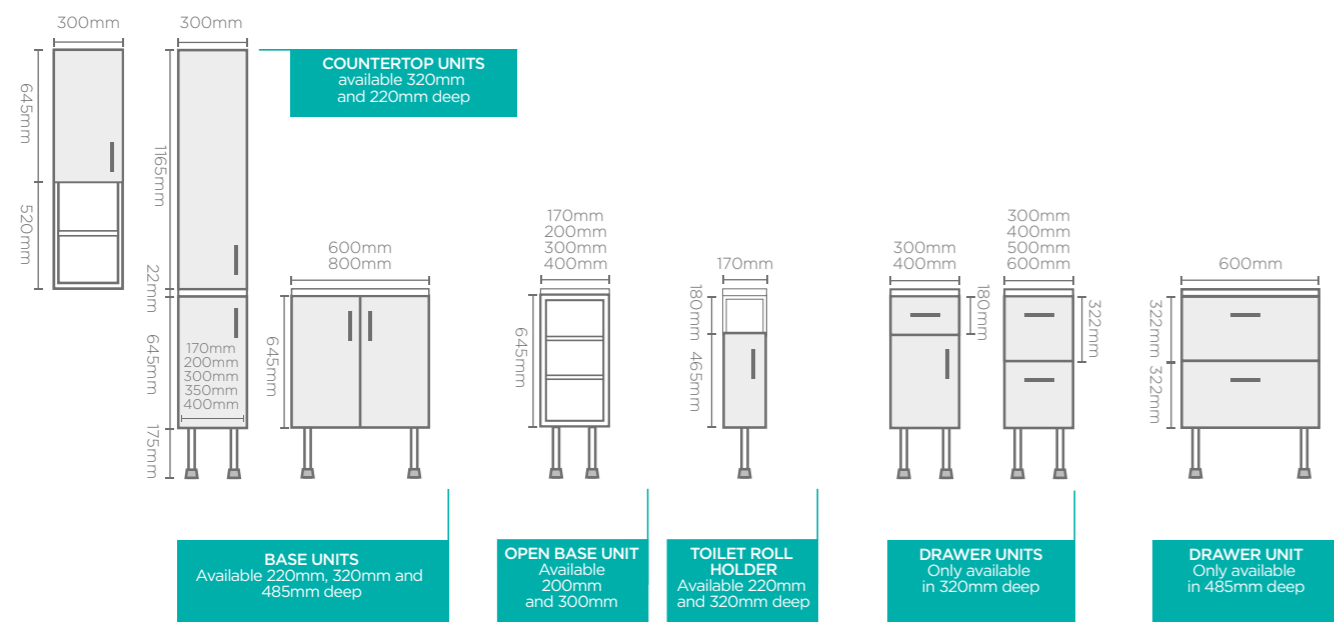

BASE UNITS

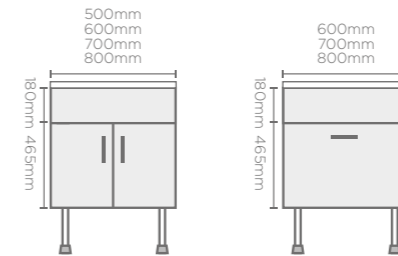

DOUBLE BASIN UNITS
available 220mm, 320mm and 485mm deep

BASIN UNIT WITH SINGLE DRAWER
Only available 320mm deep

WC UNITS

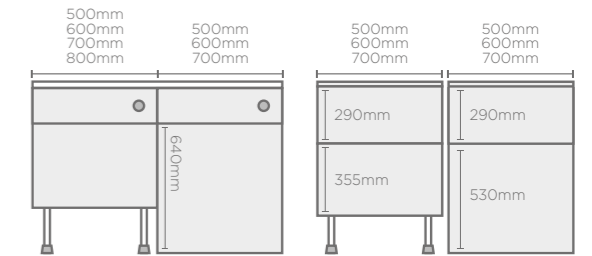

WC UNITS
available 320mm and 220mm deep

WC UNIT WITH STORAGE
available 320mm deep

MODULAR UNITS

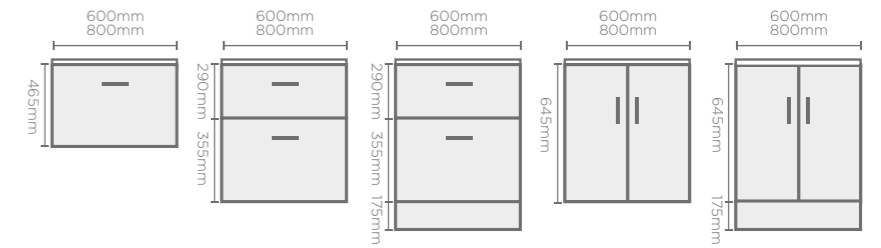
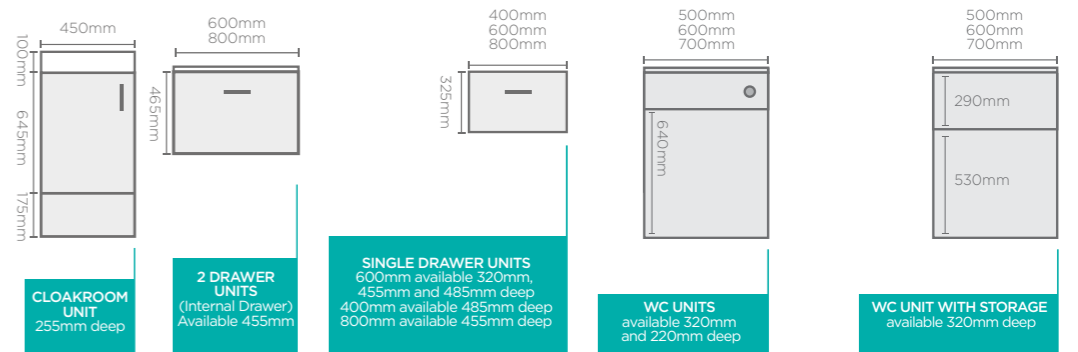

VANITY UNITS
350mm and 455mm deep

STRETTON CABINET SIZES AND OPTIONS

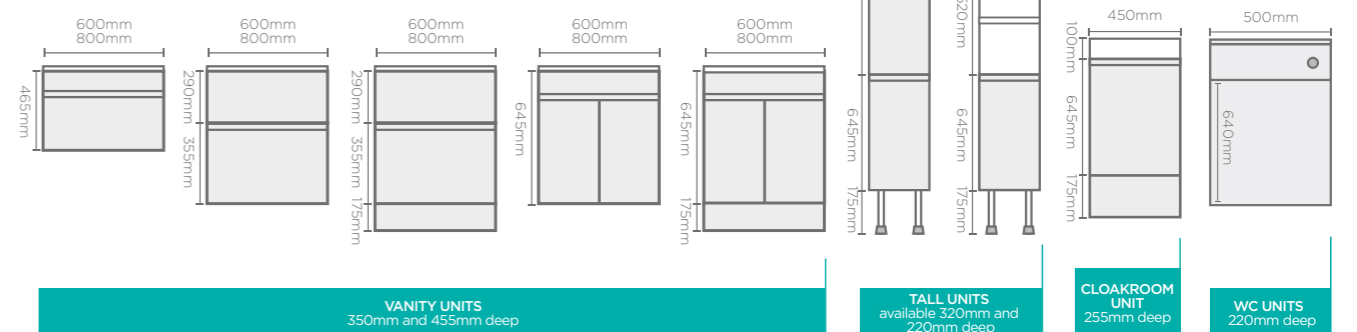

We offer a guarantee, from date of purchase, in respect of faulty materials or workmanship on all products manufactured by Ellis.

This guarantee is limited to domestic use only by the end user and is based on all products being used in the manner for which they were intended and will be invalid if the products have been abused or misused in any way. The guarantee does not cover general wear and tear. Should a product or part of a product fail during the guarantee period, we will offer a replacement part or a product of nearest available equivalent. Liability is limited to the individual product and does not cover any consequential loss, damage or further installation costs incurred. The guarantee does not cover electrical goods.

For full terms and conditions please contact our offices.

COLOUR REPRODUCTION

Whilst every care has been taken to ensure that the contents of this brochure are correct at the time of going to press, the information is for guidance only. All colours shown are reproduced as faithfully as the four colour printing process will allow.

AMENDMENTS

Our policy is one of continuous improvement. Ellis reserve the right, therefore, to amend specifications without prior notice.

SOLID TIMBER AND VENEER FINISHES

J.T. Ellis & Co. Ltd. does not guarantee to provide totally matching colours, this is due to the many different materials used in the construction of our furniture. Some shade, colour and grain variation is a natural feature of all real timber due to the natural composition of the material. Even timber taken from the same log will often show variations when stain and lacquer are applied. Since our furniture is made up of a combination of different materials, some natural and some man-made, there are inevitably some variations. J.T. Ellis & Co. Ltd. works very hard to minimise these variations.

CARE AND MAINTENANCE

Most everyday stains may be removed from units, door fronts and worktops by cleaning with a cloth dampened with soapy water. Do not use any abrasive cleaning agents or scouring pads, wire wool or any similar cleaning aids. Spillages should be wiped off immediately as any liquids left standing can cause damage to worktops, units and plinths. Never chop food or place hot dishes directly on worktops or sinks.

INSTALLATION

Installation should only be carried out by appropriately trained installers. Ellis cannot be held responsible for damage to products during installation, nor for deterioration of product caused as a result of faulty installation.



ISO 9001: 2015
Cert No FM 10459



ISO 45001
Cert No OHS 557979



ISO 14001: 2015
Cert No EMS 508575



J.T. Ellis & Co. Ltd.

Silver Street
Huddersfield
West Yorkshire
HD5 9BA

Tel: **+44 (0) 1484 242602**
e-mail: **bathrooms@jtellis.co.uk**
web: **www.jtellis.co.uk**